



GENUINE PARTS

INSTALLATION INSTRUCTIONS

1. **DESCRIPTION:** Fog Lamp Kit
2. **APPLICATION:** Altima
3. **PART NUMBER:** 999F1 UZ000 - Fog Lamp Kit

4. KIT CONTENTS:

Item	QTY	Description	Service Part Number
A	1	Combination Switch	25560 3TPOA
B	1	RH Fog Lamp Assembly	26150 8993A
C	1	LH Fog Lamp Assembly	26155 8993A
D	2	Fog Lamp Harness	24033 3KA0A
E	4	Spring nut type E	89-67106-5A
F	4	Screw-tap, hex flg type 46	85-66620-5A

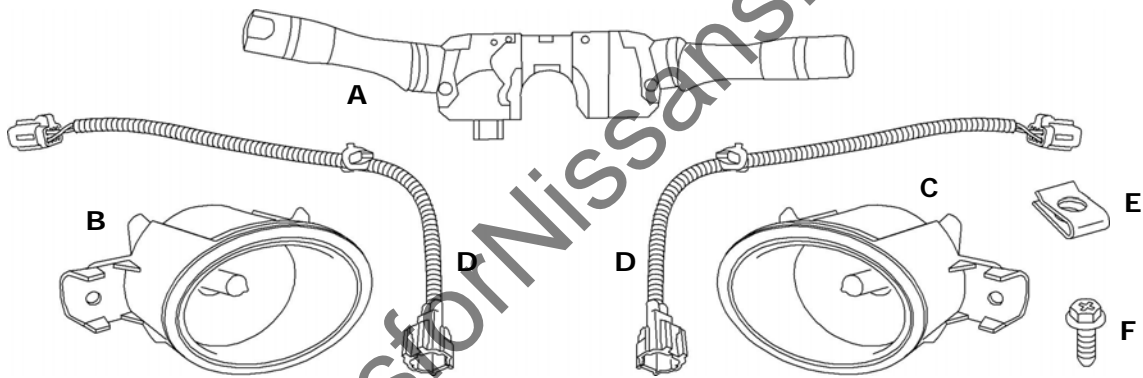

5. TOOLS REQUIRED

- Trim stick
- #2 Philips screwdriver
- Protective cloth
- Short #2 Philips screwdriver
- Short, 1/4" ratchet drive with 10mm Socket
- Electrical tape, masking tape.

6. PRE-INSTALLATION CAUTION/NOTES

- Dealer installation recommended. Instructions may refer to Service Manual
- Installation may require special tools
- This part is to be installed at a surface temperature no warmer than 65-100°F
- Remove and prepare templates located at the end of Installation Instructions

⚠ CAUTION

- This accessory must only be installed as specified in these instructions.
- Ensure at all times that parts are securely fitted and will not compromise the safe function of vehicle systems.

INSTALLATION INSTRUCTIONS - Fog Lamp Kit

7. INSTALLATION OVERVIEW

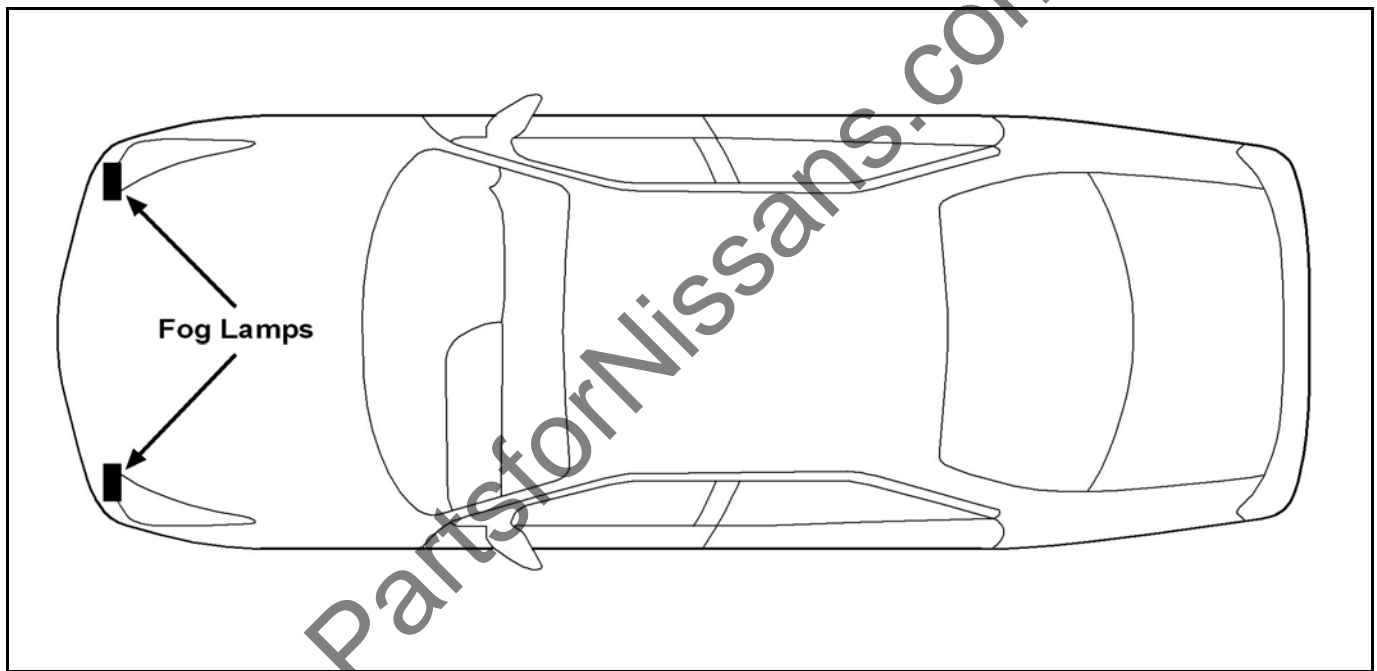
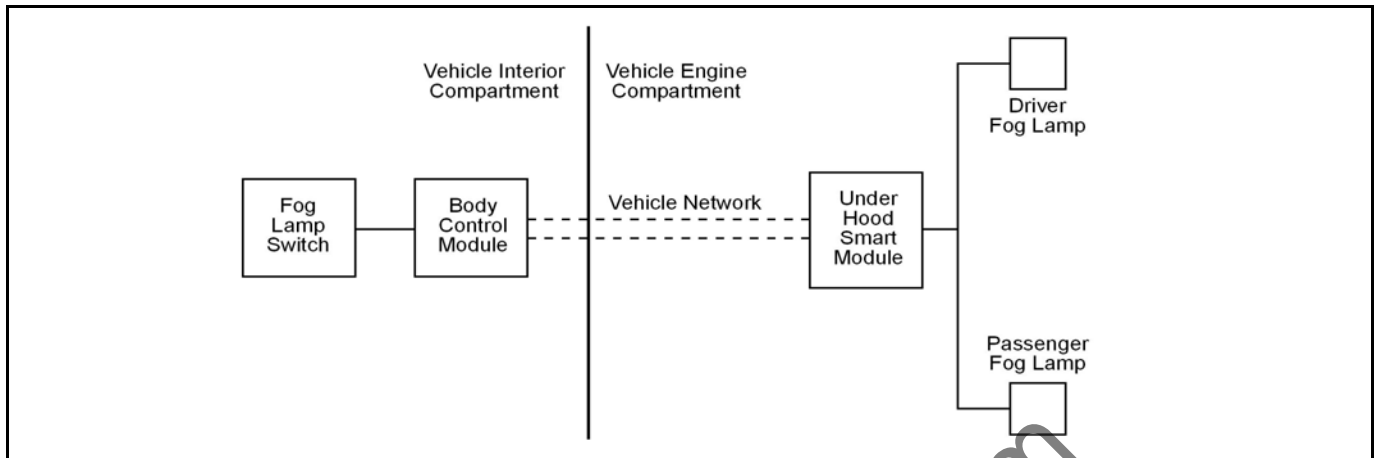

8. CRITICAL STEPS

The following steps are critical and must be performed **EXACTLY** as specified to ensure proper installation:

- Location of the lights must be followed exactly as described in this instruction.
- Be sure to apply masking tape as needed in order to protect any areas that may become scratched or damaged by tools.
- Be sure to apply foam tape to any wiring components that can be damaged over time by sharp edges.
- Test the functionality of the kit before final clean up and reinstallation of interior panels.

INSTALLATION INSTRUCTIONS - Fog Lamp Kit

9. VEHICLE PREPARATION:

- 1) Apply parking brake
- 2) Confirm the vehicle is no longer in the default shipping state (Extended Storage Switch Pulled Up and BCM in Transit Mode). Failure to confirm the vehicle has been removed from this state will result in the loss of normal vehicle operation. The confirmation requires two checks:
 - 2a) Locate the Extended Storage Switch in the cabin fuse block. Once located, check that it is in the "Customer" position. See below for reference.
 - 2b) Turn the ignition switch from "OFF" to "ON" position. If turn indicators illuminate for approx. 1 minute, the vehicle is in shipping mode. To exit shipping mode, return the ignition switch to "OFF" position. Simultaneously push the wiper and turn signal stalks downward and hold for 2 seconds.

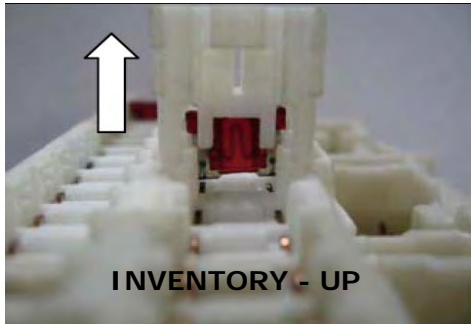
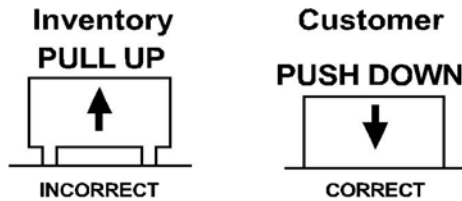

NOTE: Typical vehicle condition shown here. Switch is easily identifiable by the permanent, push-pull fuse holder. Actual position on the fuse block may vary, vehicle to vehicle.

- 3) Record customer radio presets.

	1	2	3	4	5
A					
B					
C					

NOTE: USE CAUTION WHEN REMOVING / RE-INSTALLING TRIM COMPONENTS TO AVOID DAMAGE, SCRATCHES, BREAKING OF CLIPS AND / OR INTERIOR TRIM PANELS. MOVE ALL TRIM COMPONENTS TO A PROTECTED AREA.

⚠ WARNING

Disconnect negative battery terminal before proceeding.

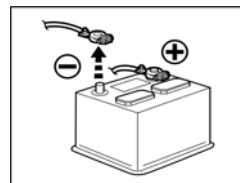

10. Order of Installation

1. Remove panels and trim.
2. Install Fog Lamp Assemblies
3. Route Wiring
4. Replace all panels

INSTALLATION INSTRUCTIONS - Fog Lamp Kit

11. INSTALLATION

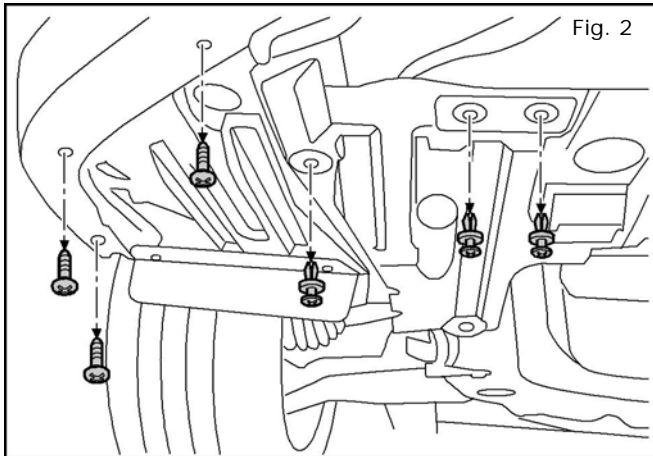

1. **RAISE VEHICLE ON HOIST**
2. Begin on **passenger** side of vehicle. Locate the lower cover panels under the front fascia. Remove three (3) phillips head screws. Remove three (3) retaining clips. Set all fasteners aside for later reinstallation.

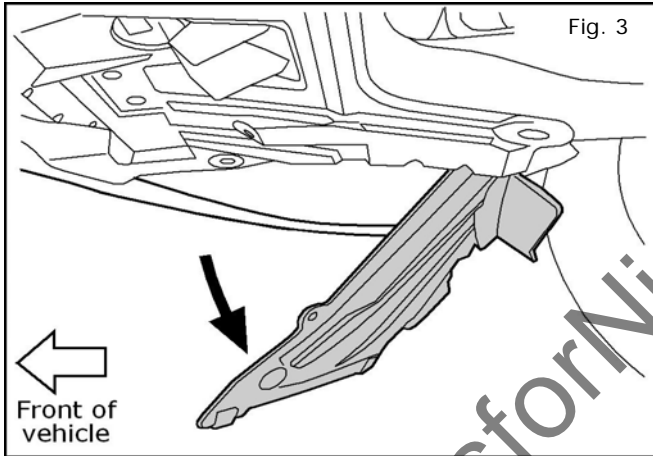

3. Carefully pry down on the lower cover panel directly in front of the wheel.

Note: Panel does not need to be removed from vehicle.

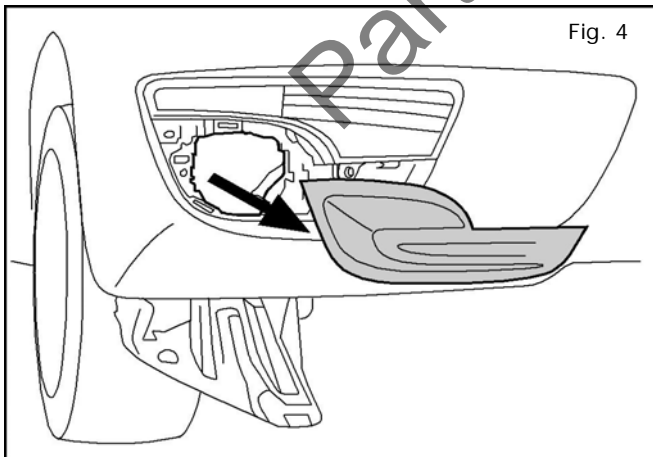

4. Carefully pry off the passenger side fog lamp finisher cover by depressing the retaining tabs on the inside of the fascia. Push the finisher cover outward from behind.

INSTALLATION INSTRUCTIONS - Fog Lamp Kit

11. INSTALLATION

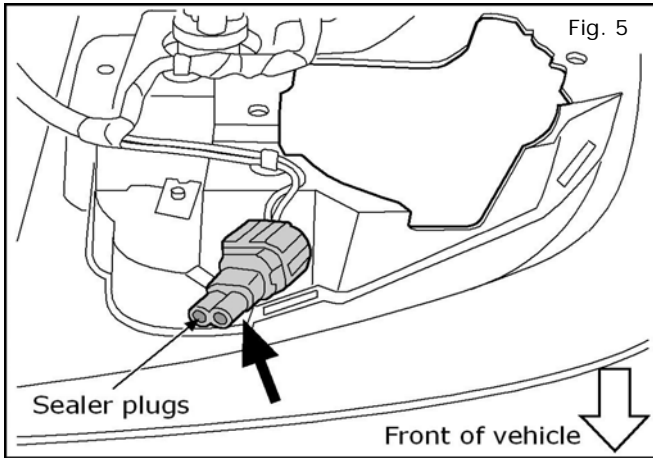

5. Locate the pre-wire harness connector inside the lower edge of the fascia.

Remove the sealer plugs from the connector and discard.

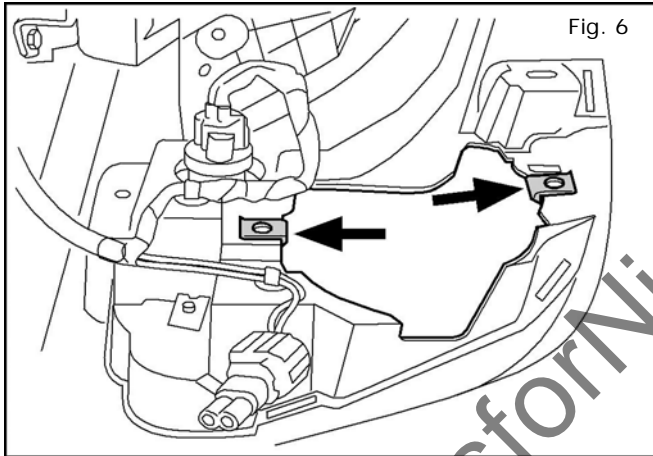

6. Install two (2) clips nuts on the left and right sides of the fascia opening as shown.

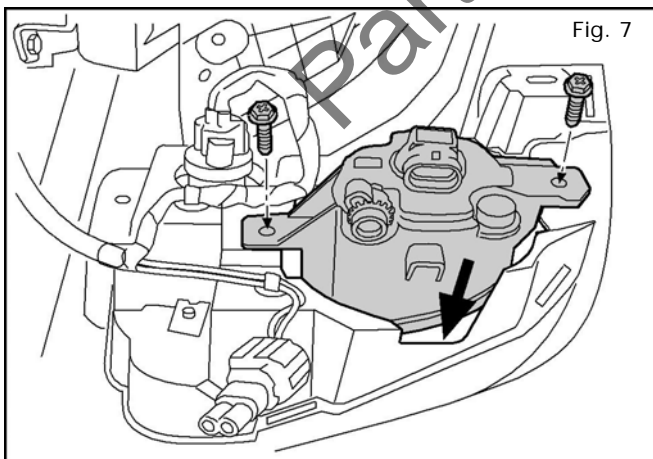

7. Install fog lamp assembly into fascia and secure with two (2) 10mm self-tapping bolts.

INSTALLATION INSTRUCTIONS - Fog Lamp Kit

11. INSTALLATION

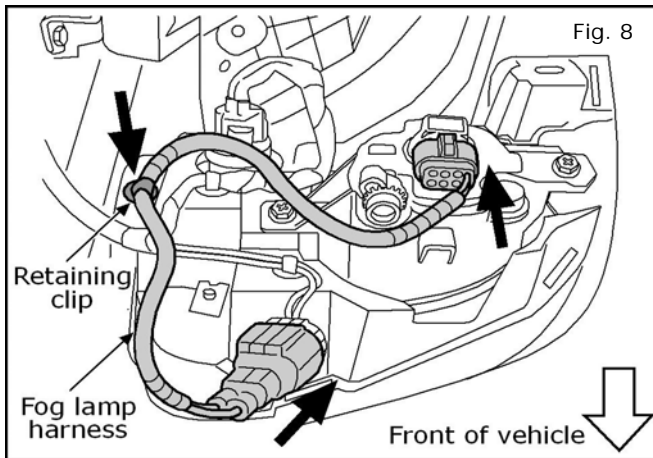

8. Plug the fog lamp harness into the connector at the back of the fog lamp. Plug the other end of the harness into the pre-wire vehicle harness connector.

Secure the fog lamp harness to the fascia with the retaining clip as shown.

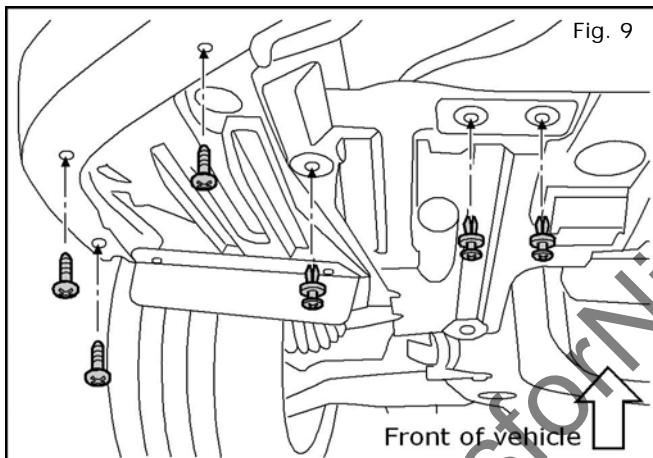

9. Carefully press the lower cover panel back into position. **Reinstall** the lower cover using the three (3) phillips head screws and three (3) retaining clips.

Repeat steps 2-9 for the driver side of the vehicle.

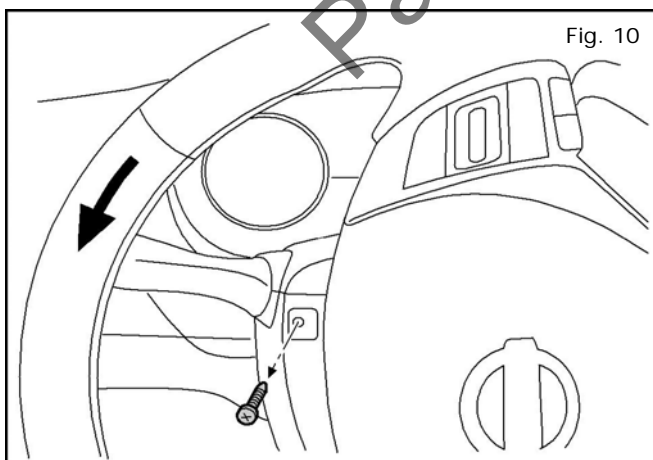

SWITCH INSTALLATION

10. Turn key to ACC position to unlock steering wheel. Rotate the steering wheel counter clockwise to access the left steering column cover screw. Remove one (1) phillips head screw.

INSTALLATION INSTRUCTIONS - Fog Lamp Kit

11. INSTALLATION

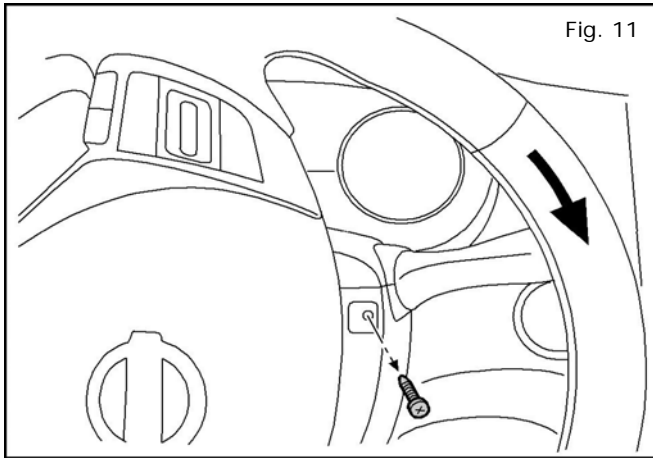

11. Rotate the steering wheel clockwise to access the right steering column cover screw. Remove one (1) phillips head screw.

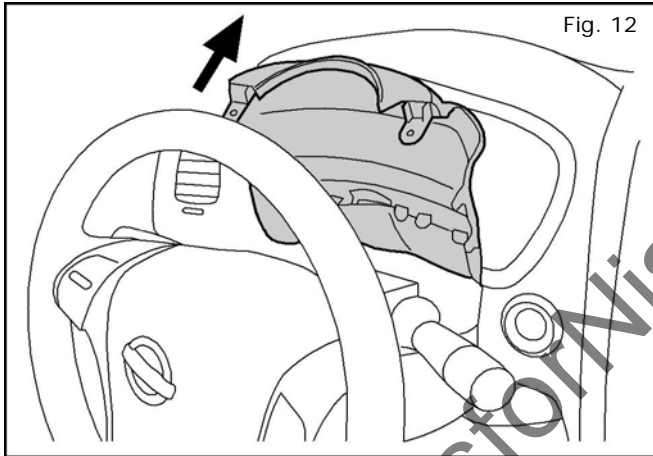

12. Carefully pry the upper steering finisher off the steering column.

Note: Upper steering finisher does not need to be removed completely.

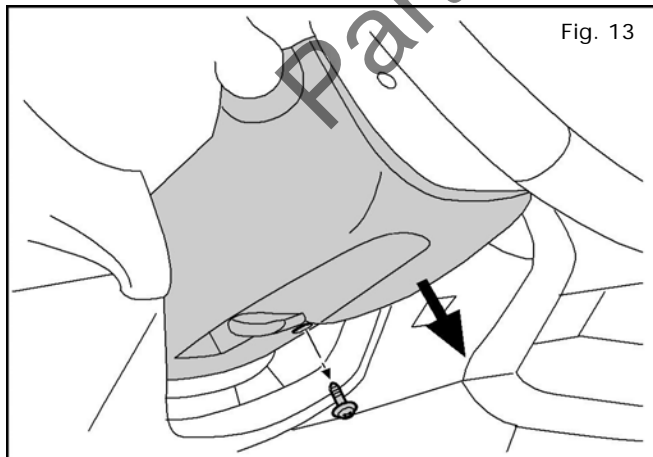

13. Remove one (1) phillps screw from the lower steering finisher. Carefully pry the lower steering finisher off the steering column.

INSTALLATION INSTRUCTIONS - Fog Lamp Kit

11. INSTALLATION

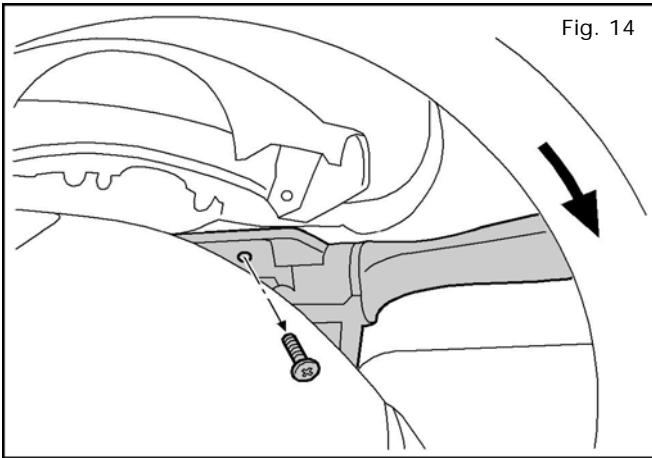

14. With the steering wheel turned to the right, use a phillips head screwdriver to remove one (1) combination switch mounting screw.

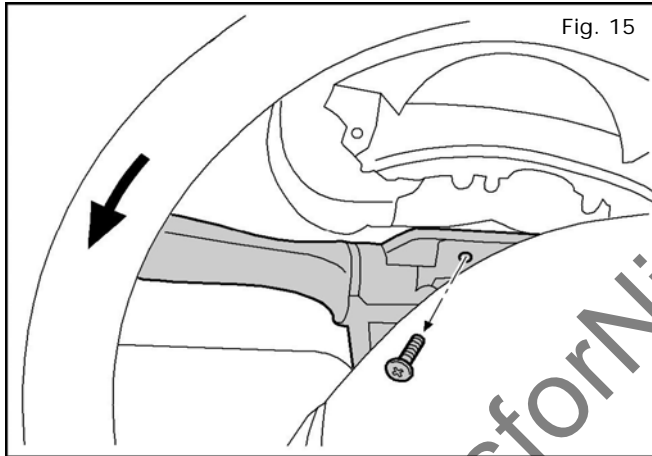

15. Rotate the steering wheel counter clockwise and remove one (1) combination switch mounting screw on the left.

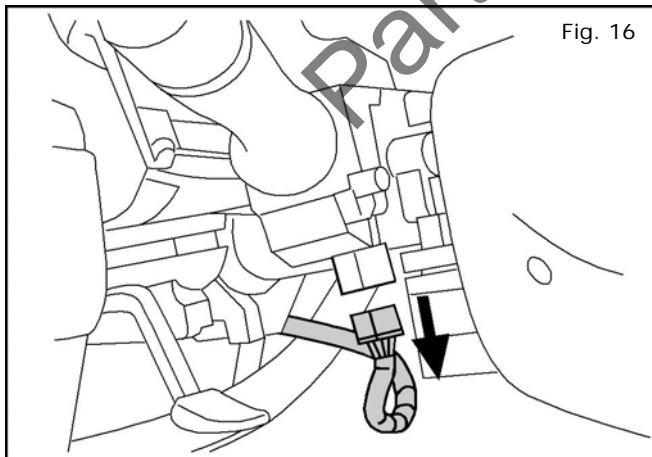

16. Locate the combination switch connector plug on the underside of the steering column and disconnect.

INSTALLATION INSTRUCTIONS - Fog Lamp Kit

11. INSTALLATION

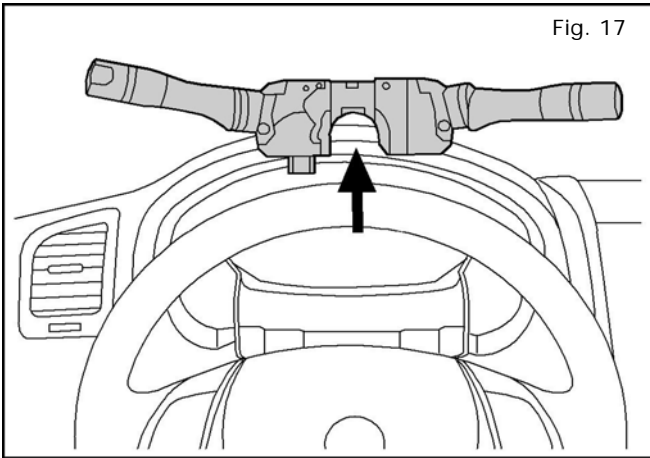

17. Remove the combination switch by lifting up and out of steering column.

Discard the combination switch assembly.

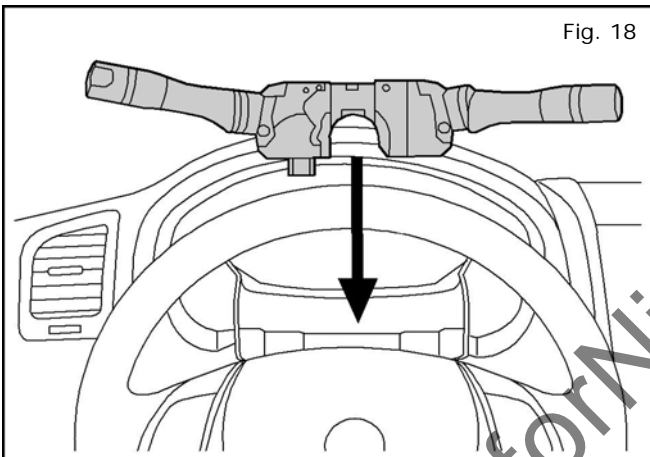

18. **Install** the new combination switch supplied with the kit using the original mounting screws.

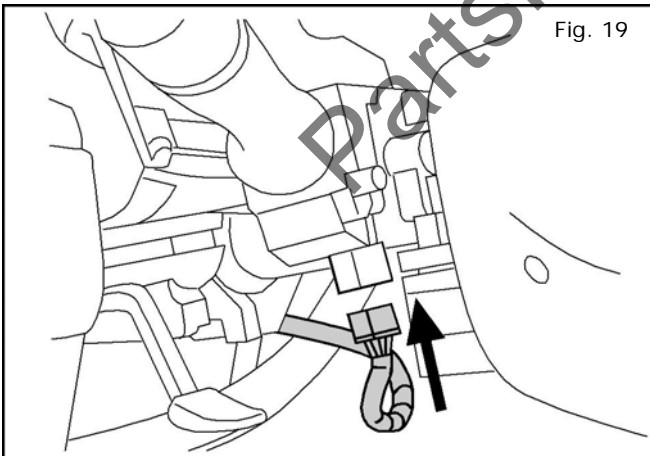

19. **Reconnect** the wiring plug to the new combination switch.

20. **Reinstall** the lower steering finisher (see Fig. 13).

21. **Reinstall** the upper steering finisher (see Fig. 12).

22. **Reconnect** the negative battery cable.

Note: Be sure to check all wiring. Make sure all trim is in place.

INSTALLATION INSTRUCTIONS - Fog Lamp Kit

12. CHECK OUT

Inspect the vehicle for unfinished work.

- 1) Turn ignition switch ON.
- 2) Turn headlamp and fog lamp switches ON.
- 3) Verify headlamps and fog lamps are illuminated.
- 4) Turn headlamp switch OFF (leaving fog lamp switch ON).
- 5) Verify both headlamp and fog lamps turn off.
- 6) Verify turn signal, wiper, washer and high beam functionality.

PartsforNissans.com

INSTALLATION INSTRUCTIONS - Fog Lamp Kit

16. BILL OF MATERIALS

Fog Light Kit - 999F1 UZ000

	Parts Contained in Bag Labelled 'Installation Kit'.	Qty	Part Number
1	Combination Switch	1	25560 3TPOA
2	RH Fog Lamp Assembly	1	26150 8993A
3	LH Fog Lamp Assembly	1	26155 8993A
4	Fog Lamp Harness	2	24033 3KA0A
5	Spring nut type E	4	89-67106-5A
6	Screw-tap, hex flg type 46	4	85-66620-5A
7	INSTALLATION INSTRUCTIONS (WEB); REV N	1	999F1 UZ000 II

PartsforNissans.com

INSTALLATION INSTRUCTIONS - Fog Lamp Kit

17. MECHANIZATION

